



REINFORCED SOIL SLOPES AND EMBANKMENTS

Design Manual and Installation Guideline For:

- Reinforced Steep Slopes
- Surficial Stability
- Reinforced Surface Soils
- Embankments Over Soft Soils
- Temporary Walls
- Pressure Relief Walls

STRATA SYSTEMS

380 Dahlonega Rd, Suite 200
Cumming, Georgia 30040
USA

Table of Contents

	Page No.
REINFORCED STEEP SLOPES	3-10
DESCRIPTION	3-4
ANALYSIS	4
Detailed Analysis Methods	5-7
Simple Wedge Methods	7-10
SURFICIAL STABILITY	11-14
DESCRIPTION	11
Slope Angles < 45 degrees	11-12
Slope Angles \approx 45 degrees	12
Slope Angles > 45 degrees	13-14
SURFICIAL STABILITY DESIGN	15-16
DESCRIPTION	15
ANALYSIS	15-16
EMBANKMENTS OVER SOFT SOILS	17-21
DESCRIPTION	17
ANALYSIS	18-21
TEMPORARY WALLS	22
DESCRIPTION	22
ANALYSIS	22
PRESSURE RELIEF WALLS	23-24
DESCRIPTION	23
ANALYSIS	23-24
SUMMARY	25
EXAMPLE CALCULATION	26-33
EXAMPLE NO.1 – REINFORCED STEEP SLOPE	27-32
COMMENTS	33
STANDARD GEOGRID SPECIFICATION	34-41
SLOPE REINFORCEMENT – PRELIMINARY DESIGN & COST ESTIMATE SHEET	42-44

The information contained in this document has been carefully compiled by Strata Systems, Inc., and to the best of our knowledge is accurate. Final determination of the suitability of any information or material is the sole responsibility of the user. Structural design shall be performed by a licensed design professional.

REINFORCED SOIL SLOPES AND EMBANKMENTS

For the purposes of this document, a reinforced slope is defined as a compacted fill embankment that incorporates the use of horizontally placed geosynthetic reinforcement to enhance the stability of the soil structure. This broad definition encompasses many and varied applications. In this manual, the following reinforced slope applications will be covered:

- Reinforced Steep Slopes
- Surficial Stability of Embankments
- Embankments Constructed Over Weak Soils
- Temporary Walls
- Pressure Relief Walls

Each application will be addressed individually in the following sections. A brief description of the various structures will be given, as well as a short explanation of the analysis procedures. Finally, an installation guideline will be presented.

REINFORCED STEEP SLOPES (RSS)

DESCRIPTION

The engineer's ability to increase usable property economically has become an important factor in all segments of property development. Increasingly, residential, commercial and industrial developers as well as transportation and infrastructure facilities designers are faced with the challenge of maximizing land use in areas that often have both difficult topographic characteristics as well as difficult soil conditions.

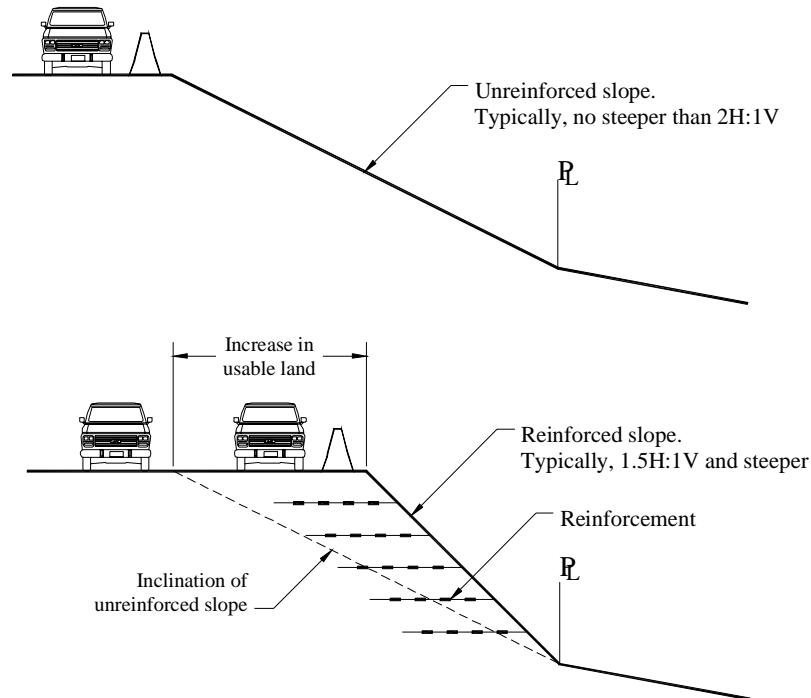

Figure 1. Available Land for Unreinforced vs. Reinforced Slopes

The illustrations on Figure 1 clearly indicate the advantage of steep reinforced slopes in increasing the usable land for change-of-grade applications. In addition, the additional cost associated with the design and construction of reinforced steep slopes is far less than the costs associated with comparable alternates (i.e., cast-in-place concrete walls, soldier piles and lagging, soil nailing, etc.). For reinforced steepened slopes, the reinforcement works with the compacted soil to create a stable mass that has enhanced geotechnical properties. Thus, slopes with surface inclinations greater than the natural angle of repose of the soil, can be constructed. This feature can lead to many interesting benefits such as creating usable space at the top (Figure 1) or toe of the slope, significantly reducing the amount of fill required to construct the slope and, as mentioned earlier, eliminating the expense of costly facing elements.

ANALYSIS

Reinforced slopes are currently analyzed using modified versions of the classic limit equilibrium slope stability methods. A circular or wedge-type potential failure surface is assumed, and the relationship between driving and resisting forces or moments determines the slope's factor of safety. Reinforcement layers intersecting the potential failure surface are assumed to increase the resisting moment or force.

The design process must address all possible failure modes that a reinforced (or unreinforced) slope will potentially experience (see figure 2). The design process must address:

- Internal stability for the condition where the failure plane crosses the reinforcement,
- External stability for the condition where the failure plane is located outside and below the reinforced soil mass; and,
- Compound stability for the condition where the failure plane passes behind and through the reinforced soil mass.

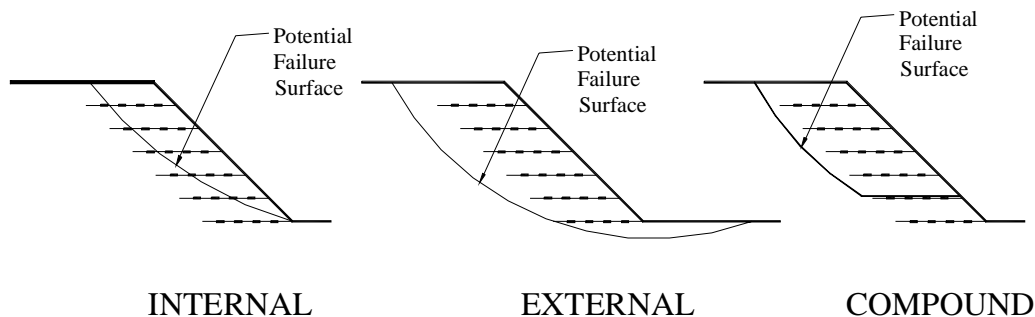

Figure 2. Failure Modes of Reinforced Slopes

Detailed Analysis Methods

One approach to the design of reinforced soil slopes is to determine the required strength of reinforcement by means of detailed limit equilibrium analysis methods such as the Bishop modified method. The Bishop modified method of analysis can be extended to include the effect of tensile reinforcement. When a failure surface intersects a reinforcement layer, an additional resisting moment is added to the overall moment of equilibrium. A model for a rotational slip surface is presented in Figure 3. In a conservative approach, the deformability of the reinforcements is not taken into account; therefore the tensile force is assumed to be horizontal, as shown in Figure 3.

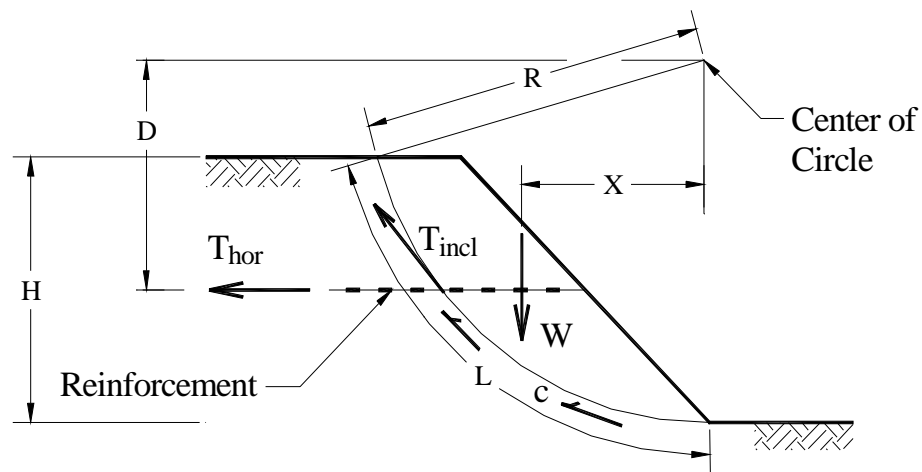

Figure 3. Model for Detailed Analysis Method

The procedure requires that the most critical surface through the toe be located for the unreinforced case. Since it is assumed that the foundation soils are competent and capable of sustaining the load of the slope construction, only failure surfaces through the toe of the slope need be examined at this point.

The Factor of Safety (FS_u) for the unreinforced section is calculated as follows:

$$FS_u = \frac{c \times L \times R}{W \times x} = \frac{M_R}{M_D}$$

where M_R = Resisting Moment
 M_D = Driving Moment
 c = cohesion (psf)
 L, R, W, x = as defined in Figure 3

The contribution of the reinforcement can be added directly to the resisting moment and the Factor of Safety (FS_r) for the reinforced section is calculated as follows:

$$FS_r = \frac{M_R + M_G}{M_D} = \frac{M_R + (T_{hor} \times D)}{M_D}$$

where M_G = the resisting moment due to reinforcement
 T_{hor}, D = as defined in Figure 3

Note that the orientation of the reinforcement tensile force influences the calculation of the resisting moment due to the reinforcement and, thus, the Factor of Safety. As mentioned previously, the conservative approach is to consider the reinforcement tensile force (T_{hor}) to act horizontally. The maximum value that the resisting moment due to reinforcement can have is:

$$M_G = T_{incl} \times R$$

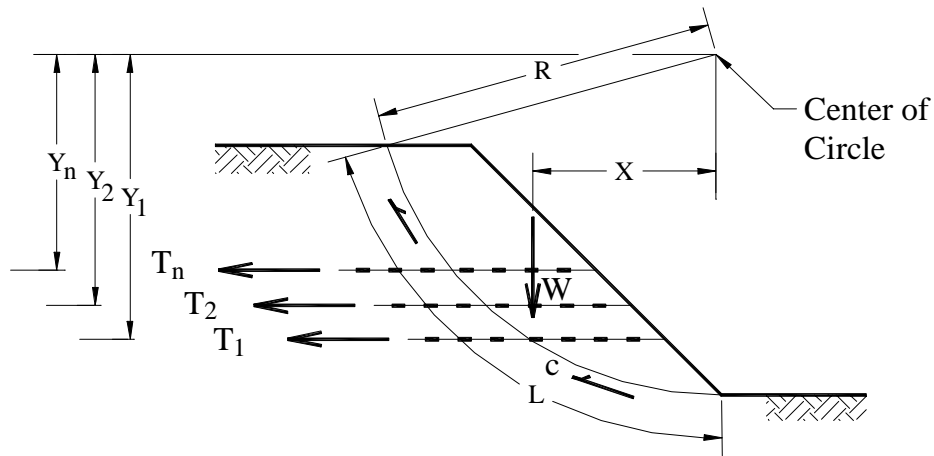

Figure 4. Model for Multi-Layered Reinforcement Slope

Calculation of the resisting moment due to reinforcement for a multi-layered reinforced slope (Figure 4), is given below:

$$M_G = \sum_1^n T_i \times Y_i$$

Finally, the embedment length of the individual reinforcement layers beyond the critical failure surface must be sufficient to provide adequate pullout resistance. The most frequently used equation to determine the required embedment length (L_e) of a reinforcement element is as follows:

$$L_e = \frac{R_{po} \times FS}{2 \times C_i \times \sigma_n \times \tan \phi_i}$$

where R_{po} = pullout resistance
 C_i = Coefficient of interaction for pullout (as per GRI: GG5)
 σ_n = normal stress acting over geogrid anchorage length

- ϕ_i = peak angle of friction for the reinforced soil
- FS = factor of safety for pullout failure

Depending on the design specifications, minimum embedment lengths of one (1) foot to one (1) meter beyond the failure surface have been required.

Simple Wedge Methods (Schmertmann *et al*, 1987)

Two-part wedge, or bilinear, limit equilibrium models provide a method for quickly checking the computer-generated results. Design charts were developed based upon simplified analysis methods of two-part and one-part wedge-type failure surfaces and are limited by the following assumptions:

- Extensible reinforcement elements are used,
- Slopes are constructed with uniform, cohesionless soil; ϕ' , $c'=0$, analysis appropriate,
- No pore pressures within the slope,
- No seismic loading,
- Competent, level foundations,
- Flat slope face and horizontal slope crest,
- Uniform surcharge load at top of slope, and
- Horizontal reinforcement layers with coefficient of interaction (C_i) equal to 0.9.

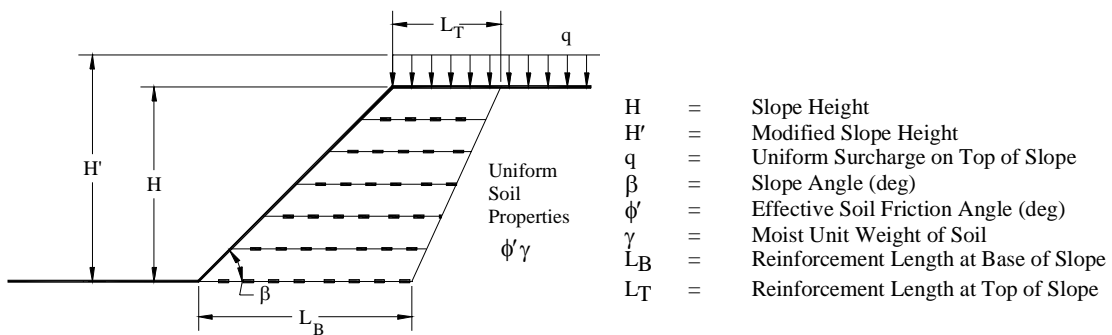

Figure 5. Slope Geometry and Definitions

By definition, solutions for limit equilibrium models are for a factor of safety (FS) equal to unity. The target, or desired, overall FS is taken into account by factoring or reducing the soil shear strengths and is calculated as follows:

$$\phi'_f = \tan^{-1} \left(\frac{\tan \phi'}{FS} \right)$$

where ϕ' = soil friction angle
 ϕ'_f = factored soil friction angle

The next step is to calculate the modified slope height (H') to take into account any uniform surcharge loading at the top of the slope. The modified slope height is calculated as follows:

$$H' = H + \frac{q}{\gamma}$$

where H , q , and γ are defined on Figure 5.

From the chart on Figure 6, determine the force coefficient K and calculate the maximum tensile force requirement (T_{\max}) from the following:

$$T_{\max} = 0.5 \times K \times \gamma \times (H')^2$$

From the chart on Figure 7, determine the required reinforcement length at the top (L_T) and at the bottom (L_B) of the reinforced section.

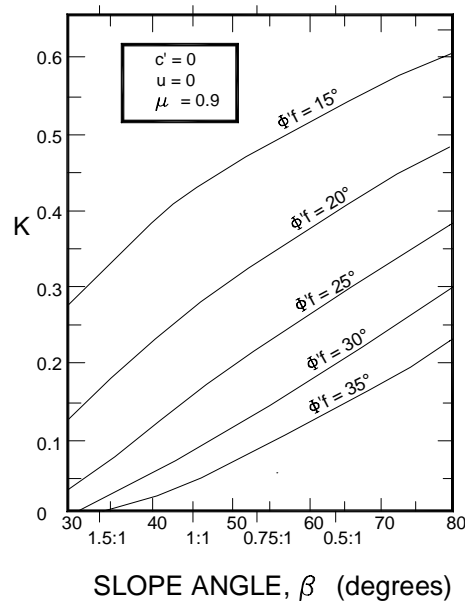

Figure 6. Reinforcement Coefficient K

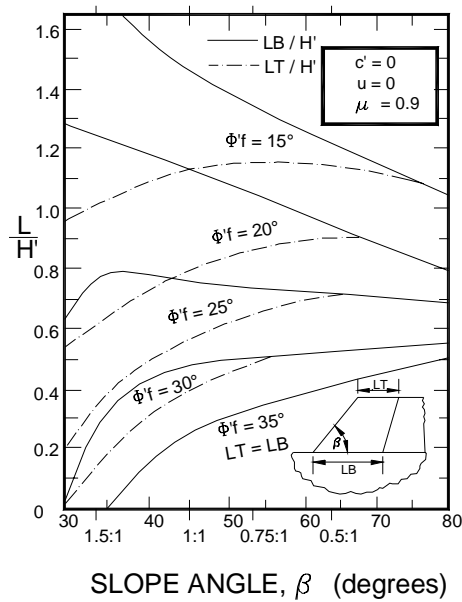

Figure 7. Reinforcement Length Ratios, L_T and L_B

The next step in the procedure is to select the appropriate primary geogrid and calculate the number of layers required. The term “primary” geogrid layer refers to the geogrid required to satisfy internal, external, and global stability requirements. At this point in the analysis, the designer must choose a geogrid so that the resulting spacing calculations yield acceptable values. For example, the spacing of primary geogrid layers at the bottom of a slope should not be less than 8 inches to 12 inches. This corresponds to typical earthwork fill thickness. Conversely, the primary geogrid spacing should be no greater than 4 feet. If calculations yield geogrid spacing less than the practical limit, then a stronger primary geogrid should be chosen. Alternatively, if the calculations yield geogrid spacing greater than 4 feet, a lighter geogrid can be selected.

To determine the appropriate geogrid, calculate the long-term design strength (LTDS) of the material as follows:

$$LTDS = \frac{T_{ult}}{RF_{CR} \times RF_{ID} \times RF_D}$$

where: T_{ult} = ultimate tensile strength of the reinforcement as per ASTM D6637,
 RF_{CR} = reduction factor due to creep,
 RF_{ID} = reduction factor due to installation damage, and
 RF_D = reduction factor due to durability.

The minimum number of geogrid layers for the reinforced section, is then calculated as follows assuming 100% coverage of the geogrid for a given vertical elevation:

$$N = \frac{T_{max}}{LTDS} \quad \text{and} \quad S_v = \frac{H}{N}$$

where N = number of geogrid layers (rounded up to the next integer)
 T_{max} = the total geogrid force (for a given section)

Note that T_{max} for a low section of slope is equal to the total geogrid force requirement for the entire height of the slope. For higher slope sections, T_{max} can be distributed over several zones. For example, for a three-zone section, one can distribute T_{max} as follows:

$$T_{Bottom} = \frac{1}{2} T_{max}$$

$$T_{Middle} = \frac{1}{3} T_{max}$$

$$T_{Top} = \frac{1}{6} T_{max}$$

In other words, the section is divided into three zones where there will be three different spacing and geogrid requirements. This results in an efficient and cost-effective design.

Pullout embedment lengths have been taken into consideration in the total length, L_T and L_B , in the chart in Figure 7.

SURFICIAL STABILITY

DESCRIPTION

As mentioned previously, primary geogrid reinforcement layers satisfy the tensile requirements for internal, external, and global stability. Typically, spacing of primary geogrid reinforcement are within the 2.5-ft to 4-ft range at the bottom of reinforced slopes, and as high as 6 feet at the top of the slope. Experience has shown that placing, compacting and maintaining a steep slope for what is equivalent to 4- to 6-ft geogrid spacing at the face of the slope is difficult and sometimes impossible.

The following section will describe several construction techniques which deal with the surficial stability of reinforced slopes.

Slope Angles < 45 degrees

The use of secondary or intermediate geogrid layers is a very useful and economic way to provide stability at the face of reinforced slopes with inclinations gentler than 45 degrees (1H:1V). Intermediate geogrid layers are relatively short layers of lightweight geogrid reinforcement placed at relatively tight spacing between the layers of primary reinforcement. In addition to providing surficial stability to the reinforced slope, the intermediate geogrids provide a better platform for compaction equipment, thus ensuring uniform soil density to the face of the slope. It may be necessary to use an erosion control mat as the final facing layer. To further analyze the surficial stability please refer to the Reinforced Surface Soils section. The cross section in Figure 8 illustrates the use of intermediate geogrid layers in a reinforced slope application where the finished slope angle is gentler than 45 degrees.

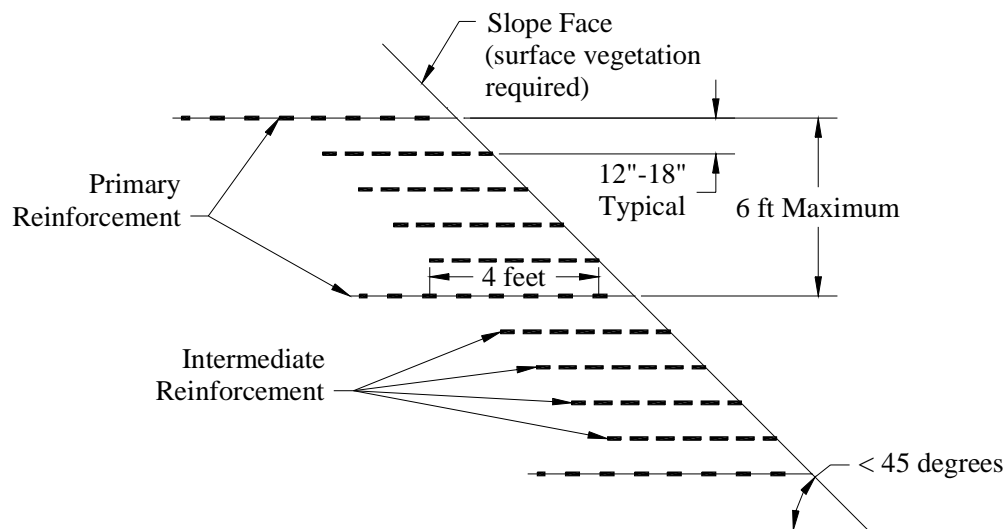

Figure 8. Cross Section of Reinforced Slope with Slope Angle < 45 degrees

Note that the spacing and length limitations indicated in Figure 8 are recommended values. Site and project specific conditions may dictate tighter restrictions.

Slope Angles \approx 45 degrees

As the inclination of the reinforced slope increases, so does the potential for surficial sloughing and erosion. As the slope angle approaches and passes 45 degrees, additional precautions must be taken to ensure long-term stability of the slope face.

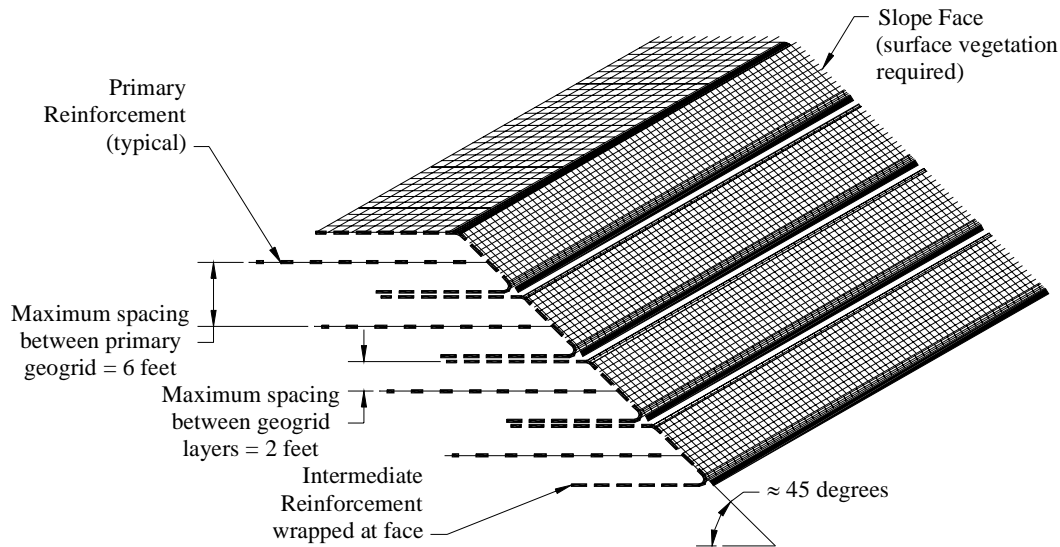

Figure 9. Cross-Section and Isometric View of Wrap-Around Face.

The cross section and isometric view shown in Figure 9 illustrates one of several methods to provide facing stability to a reinforced slope structure. The facing is referred to as a *wrap-around*, where the geogrid is wrapped around the face of the slope, thus effectively encapsulating the surface soils or the stone facing. In this particular example, the intermediate geogrid is used as the wrap-around material, and the primary geogrid is neatly tucked in between the wrap. Alternately, the primary geogrid can be used as the wrap. This alternative can prove to be costly, especially if the primary geogrid is a high strength product.

In some cases, especially when the backfill soil contains significant amounts of fine soil (i. e., fine sands, silts and clays), a geotextile separator may be placed between the soil and the geogrid wrap.

It is important to note that, although the soil is encapsulated within the wrap, surface protection in the form of vegetation is still required. It should also be noted that, over time, a geogrid wrapped faced will tend to sag and slough because of the creep behavior of the polymer geosynthetic. Therefore, to decrease the significance of the sagging of the face of the wrap, it is important to restore the vegetative cover on the face of the slope as quickly as possible. If a geotextile separator is used then vegetating the slope will be more difficult and will require more advanced methods.

Slope Angles > 45 degrees

When the inclination of a reinforced slope is significantly steeper than 45 degrees, a more permanent, rigidly formed face is necessary. The most commonly used form of rigid facing in reinforced slope applications is the welded-wire fabric facing (see Figure 10).

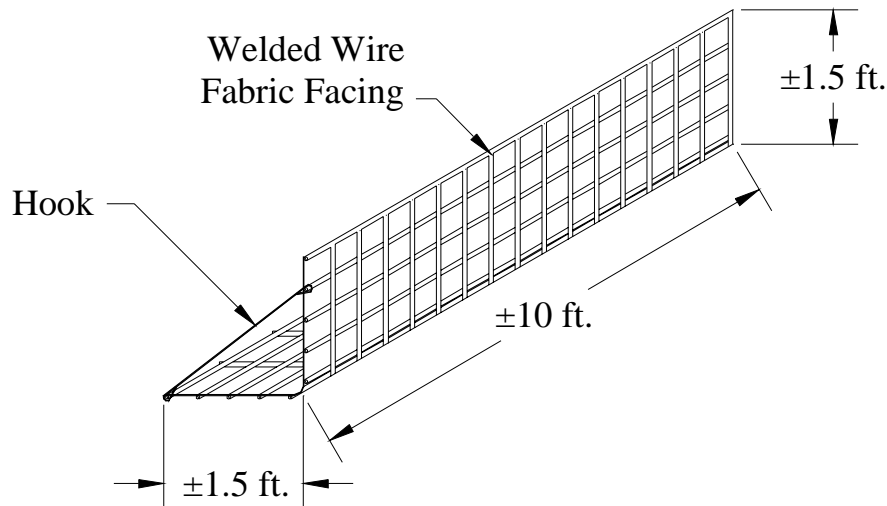

Figure 10. Isometric view of welded wire fabric facing.

The welded wire fabric (WWF) is used as the facing of the steep reinforced slope. Although the WWF can be bent to accommodate most angles, it is convenient to bend the WWF at angle of slightly less than 90 degrees. This configuration permits the easy placement and compaction of backfill soil. At angles significantly less than 90 degrees, it becomes difficult to compact the soil directly behind the WWF facing. The cross section in Figure 11 illustrates all the components of a WWF reinforced slope. After the primary geogrid and the WWF facing is in place, the intermediate geogrid is draped over the WWF facing. If required, an erosion mesh may be placed directly behind the intermediate geogrid, alternatively, stone may be used when no vegetation is required. The backfill is then placed and compacted at the appropriate lift thickness. When the backfill has reached the required elevation (i. e., at the top of the WWF) the intermediate geogrid is placed over the compacted fill.

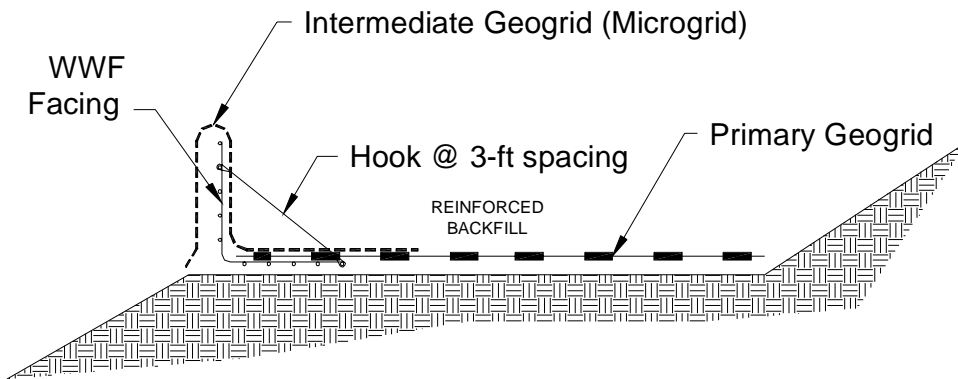

Figure 11. Components of a WWF reinforced slope.

At this point in the construction, the second level of WWF can be placed. The cross section shown in Figure 12 shows the construction sequence for a WWF reinforced slope.

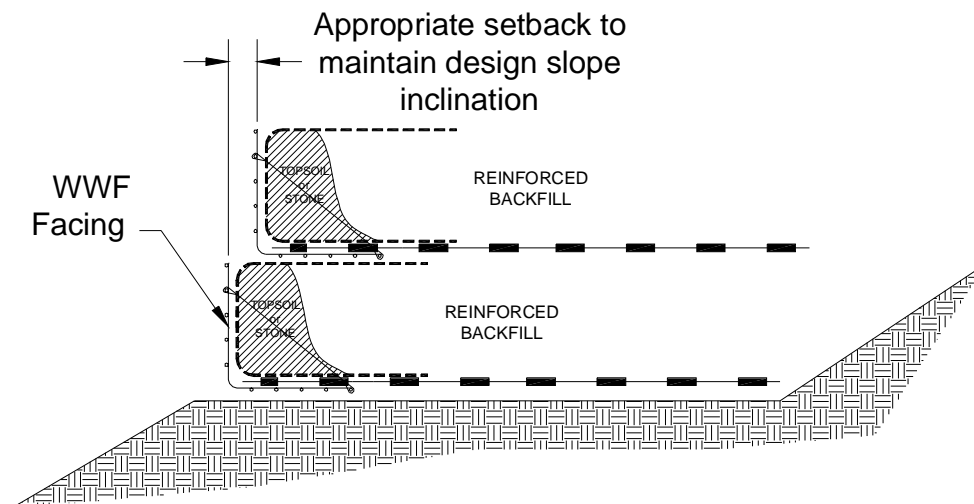

Figure 12. Construction sequence for WWF facing reinforced slope.

Note: The upper level is placed at a predetermined setback so that the overall inclination of the structure is maintained. An additional feature to the setback is that vegetation can easily take root in the flat sections created by the setback.

Facing treatment is an important component of the design and construction of reinforced steep slopes. Although the overall global stability of the reinforced steep slope may be maintained through the use of primary geogrids, neglecting the requirements of surficial stability may lead to the eventual failure of the slope.

SURFICIAL STABILITY DESIGN

DESCRIPTION

In an earlier section, it was shown that the use of horizontally placed geosynthetic reinforcement to stabilize surficial soils in slope applications is a commonplace procedure. For steep reinforced slopes, for example, relatively short secondary reinforcement layers are placed between the primary reinforcement to provided stability to the surface soil during and after construction to help with the growth of vegetation.

ANALYSIS

The cross section in Figure 17 illustrates a typical steep slope arrangement with geogrid reinforcement. Thielen *et al* (1991), proposed a method to determine the factor of safety for surficial soil failure.

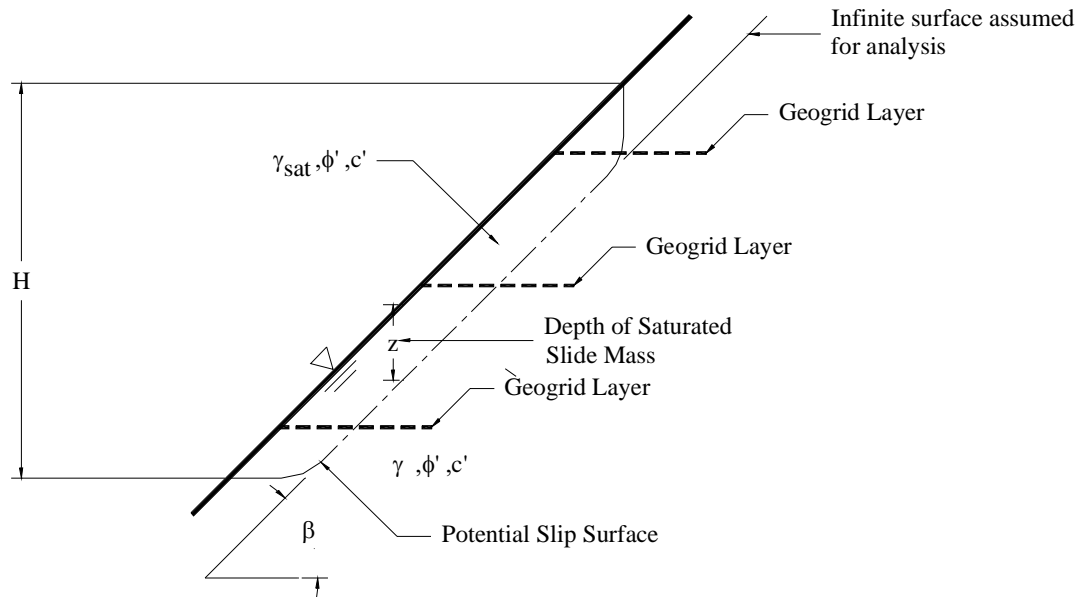

Figure 17. Surficial Soil Stability with Geosynthetic Reinforcement

The following equation calculates the factor of safety for surficial soil failure for a given reinforcement configuration along the potential slip surface with all forces parallel relative to the slope face:

$$FS = \frac{F_g [\cos \beta + \sin \beta \tan \phi'] + \frac{c'H}{\sin \beta} + (\gamma_s - \gamma_w)Hz \cos \beta \tan \phi'}{\gamma_s Hz \sin \beta}$$

where:

- F_g = total tensile strength requirement of the reinforcement.
- γ_w = unit weight of water

Thus, the factor of safety for surficial soil failure can be determined for a given reinforcement arrangement. This calculation is especially significant for conditions where the surficial soil layers are susceptible to saturation because of some event (i.e., significant rainfall, snowmelt, and the like).

Conversely, the equation can be re-arranged to yield the total tensile strength requirement for a given factor of safety.

$$F_s = \frac{FS(\gamma_s H z \sin \beta) - \left[\frac{c'H}{\sin \beta} + (\gamma_s - \gamma_w) H z \cos \beta \tan \phi' \right]}{(\cos \beta + \sin \beta \tan \phi')}$$

EMBANKMENTS OVER SOFT SOILS

DESCRIPTION

Geosynthetic reinforcement can also be used to construct embankments over soft soils. The addition of strong tensile elements in the soil embankments contribute to the resisting forces and hence the overall stability of the soil structure. Figure 13 illustrates the concept of embankment reinforcement over soft or weak soils. For embankments over weak or soft soils, the use of geogrid reinforcement may allow for an increase in the design factor of safety. In other words, if the stability analysis of the embankment, using only the geotechnical properties of the soil, yields an unsatisfactory Factor of Safety (FS), the inclusion of high tensile strength geogrids in the analysis may increase the FS to acceptable limits. Following this same argument, it may also be possible to increase the height of an embankment, if this is desirable.

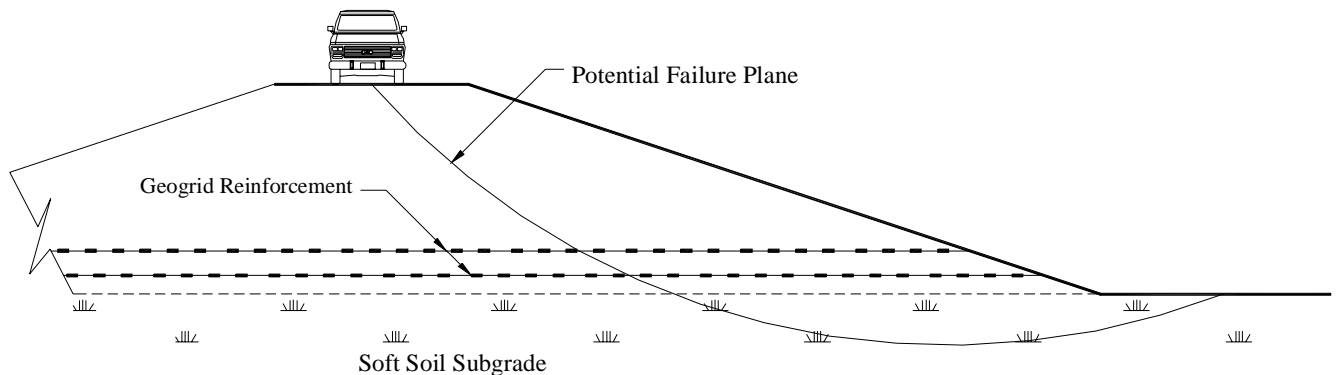
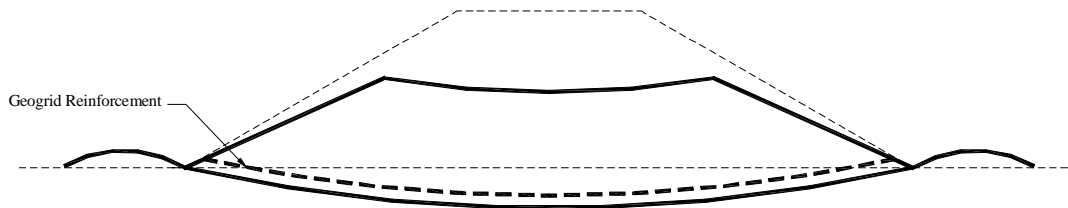

Figure 13. Reinforced embankment on soft soil.

ANALYSIS

The analysis of a reinforced embankment constructed over weak soils is more involved than the analysis for a steep reinforced slope. The major difference lies in the assumptions. For example, recall that it is assumed in the design and analysis of a steep reinforced slope that the foundation soil is competent. In itself, this assumption eliminates many of the problems involved in the design of embankments over weak soils. Therefore, the analysis of a reinforced embankment involves the following (see the illustrations on Figure 14 a) to e)):

- Verification of the overall bearing capacity,
- Verification of the overall rotational shear or global stability,
- Verification of lateral spreading or squeezing of the foundation soil, and
- Verification of allowable settlement.



a) Bearing Failure

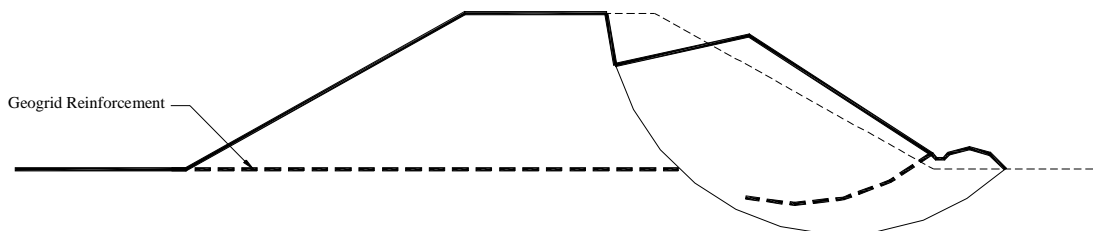

b) Global or Rotational Failure

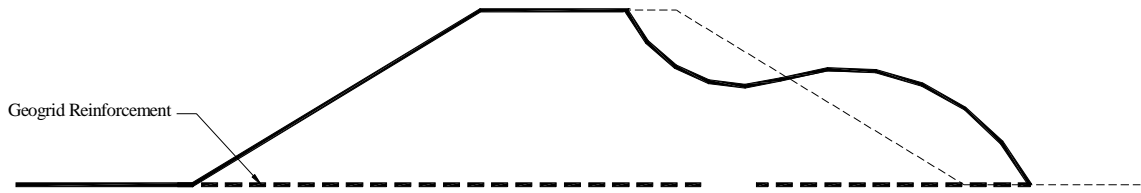

c) Lateral Spreading

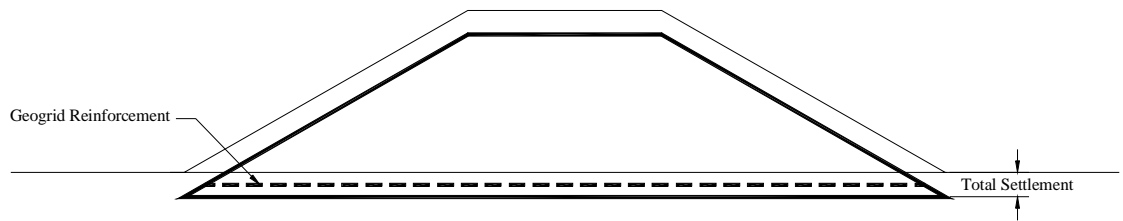

d) Settlement (excessive total settlement)

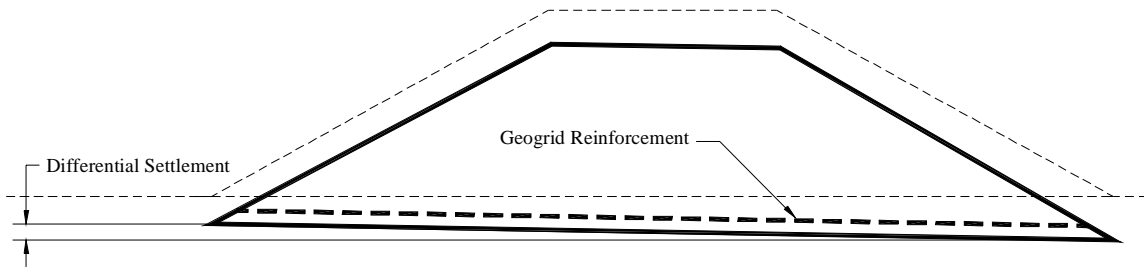

e) Settlement (excessive differential settlement)

Figure 14. Failure Modes of Reinforced Embankments Over Weak Soils

For the purposes of this document, only the rotational failure mode will be addressed. This does not minimize the importance of the remaining checks on failure modes. In fact, the analytical impact that the presence of a reinforcement element may have on an embankment may be diminished when the bearing capacity and/or settlement calculations are carried out. For example, although the presence of reinforcement at the base of an embankment may help to reduce lateral movement, it will have no effect on consolidation settlement.

For the most part, the rotational or global analysis of a reinforced structure over weak soils is similar to the analysis of a reinforced steep slope. The only difference is that in the reinforced steep slope analysis, it is assumed that the failure surface does not extend into the foundation soil because it is assumed to be competent. The section illustrated in Figure 15 demonstrates the mechanisms involved in analyzing an embankment for rotational failure.

The first step is to calculate the factor of safety of the unreinforced embankment using classical limit equilibrium stability analysis. If the resulting factor of safety is adequate, no reinforcement is required. If, however, the factor of safety is not adequate, then an increase in the factor of safety to acceptable limits may be attained by the inclusion of geogrid reinforcement. This is done by assuming that the reinforcement acts as a stabilizing tensile force at its intersection with the critical failure plane. The analysis consists of determining the most critical surface using conventional limit equilibrium analysis methods. For a given failure surface, the driving moment and the resisting moments are calculated. The additional resisting moment M_G is calculated as shown below. One or multiple layers of reinforcement with sufficient tensile strength at tolerable strains are added at the base of the embankment to provide the required additional resisting moment.

Calculation of the resisting moment due to reinforcement for a multi-layered reinforced slope (Figure 15), is given below:

$$M_G = \sum_1^n T_i \times Y_i$$

This is the same equation used for the analysis of a steep slope (Figure 4).

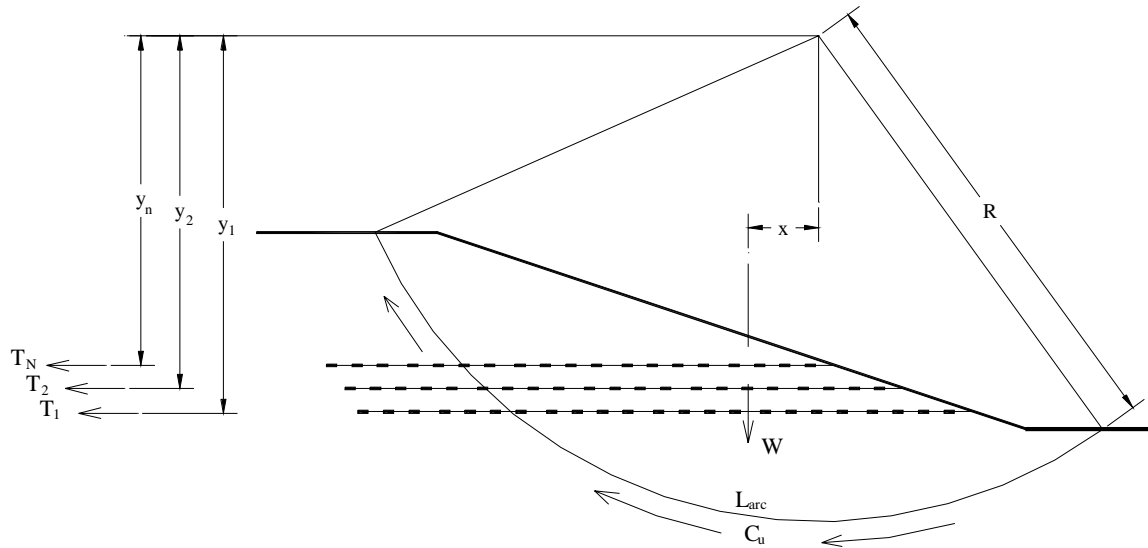

Figure 15. Embankment - Global Analysis

As explained earlier, the choice of orientation of the tensile forces due to the reinforcement is important. The conservative approach is to assume that the tensile forces act horizontally, as shown in Figure 15. The least conservative approach would be to assume that the resultant tensile forces act normal to the radius of the critical failure surface. The orientation of the resultant tensile force is a function of the type of soil and it is left to the engineer to decide its orientation.

TEMPORARY WALLS

DESCRIPTION

From time to time, there is a need to design and construct temporary walls. These walls are inexpensive, quickly constructed structures that are needed for relatively short time periods until permanent structures are erected. Oftentimes, temporary walls are used to enable traffic to continue unimpeded during construction phases. These phases may last anywhere from several months to several years. Geosynthetically-Reinforced steep slopes are ideal for these types of walls. They can be constructed relatively quickly and at low cost, especially if aesthetics are not a consideration.

ANALYSIS

Temporary walls are a special case of reinforced steep slopes. They are designed much in the same way one would design a permanent steep slope. The difference lies in the application of the reduction factors for the determination of the long-term design strength (LTDS). Recall the equation to determine the LTDS of a reinforcement geosynthetic:

$$LTDS = \frac{T_{ult}}{RF_{CR} \times RF_{ID} \times RF_D}$$

where: T_{ult} = ultimate tensile strength of the reinforcement as per ASTM D6637,
 RF_{CR} = reduction factor due to creep,
 RF_{ID} = reduction factor due to installation damage, and
 RF_D = reduction factor due to durability.

The Reduction Factors (RF) mentioned above are all based on a 75- to 100-year life for the geosynthetic. In order to determine the short-term design strength for the reinforcement geosynthetic, the RF's can be scaled up to reflect the appropriate life of the structure. This can have a significant effect on the strength and hence, the type of geogrid a designer will specify for the temporary structure. A final consideration in the design and construction of temporary walls is ultraviolet (UV) degradation of the geosynthetic. In many instances wrap-around structures are used as temporary walls and the geosynthetic is left exposed at the face of the wall during the life of the structure. Precautions should be taken to ensure that degradation of the geosynthetic due to ultraviolet light exposure does not jeopardize the integrity of the structure during its lifetime.

PRESSURE RELIEF WALLS

DESCRIPTION

The use of reinforced walls in pressure relief applications is an economical way to solve a potentially difficult and costly problem. Engineers and designers are looking to reinforced walls to reduce and even eliminate lateral earth pressures from acting on structural walls. The cross section shown on Figure 16 illustrates an example of a reinforced stress relief wall. Essentially, the best description of the system is a wall behind a wall, where the reinforced wall takes a portion or all the lateral earth pressures. In the cross section in Figure 16, the reinforced wall is designed to take all the lateral earth pressures.

In the construction of the wall, a space is left between the stress relief wall and the structural foundation wall. The space is then usually filled with a lightweight, compressible material such as sand or blocks of extruded polystyrene. This enables the stress relief wall to move without applying any significant pressure on the structural foundation wall.

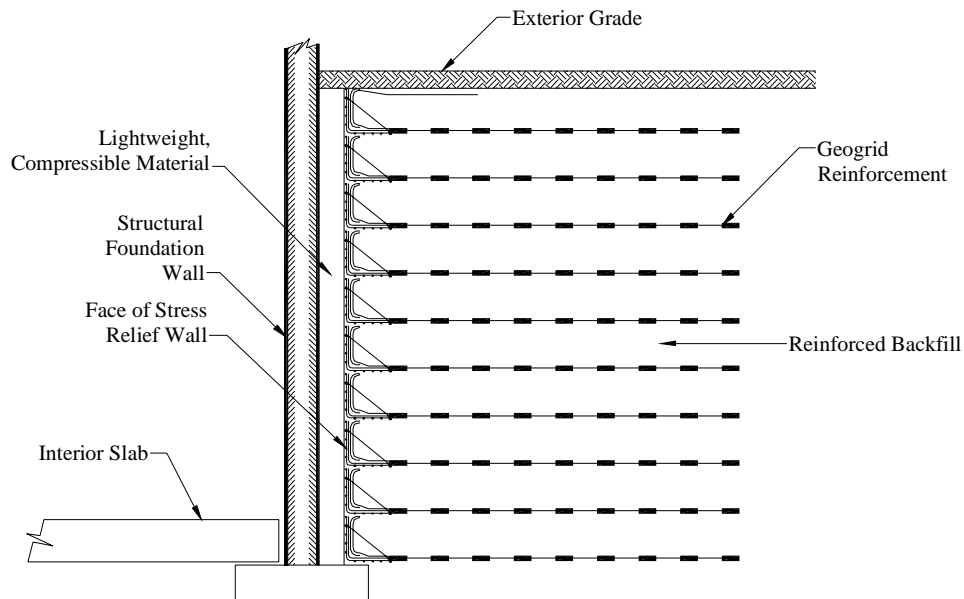

Figure 16. Cross-section of a stress relief wall.

The stress relief wall structure has been used successfully in many applications. From large underground reservoirs to marine and coastal structures to residential structures, the technique has proven to be a cost-effective solution to an otherwise difficult situation.

ANALYSIS

The analysis of the stress relief is identical to the design of a retaining wall, which is a special case of designing a steep reinforced slope with a near-vertical face. The principles described in the Reinforced Steep Slope section apply.

Special attention must be paid to the facing construction. Providing a vertical or near-vertical face without making provisions for a rigid face (i.e., SRW unit) requires special construction techniques. The construction sequence is presented in the Surficial Stability section of the manual.

SUMMARY

We have presented four commonly used applications in which reinforcement elements are used to enhance the performance of soil structures. By no means is this list exhaustive. In fact, in practice, these structures may be used in combination with each other, or with other types of geosynthetically reinforced soil structures such as retaining walls. Designed properly, these soil structures will provide the designer, contractor, and owner with a cost-effective means to build grade separation structures.

Example Calculation

Example No. 1. Reinforced Steep Slope

Given: The 45-degree slope as shown below. Assume the following assumptions are true:

- Extensible reinforcement elements are used,
- Slopes are constructed with uniform, cohesionless soil; ϕ' , $c' = 0$, analysis appropriate,
- No pore pressures within the slope,
- No seismic loading,
- Competent, level foundations,
- Flat slope face and horizontal slope crest,
- Uniform surcharge load at top of slope, and
- Horizontal reinforcement layers with coefficient of interaction (C_i) equal to 0.9.

Determine the appropriate reinforcement required to provide a stable reinforced slope with an overall factor of safety (FS) of 1.5.

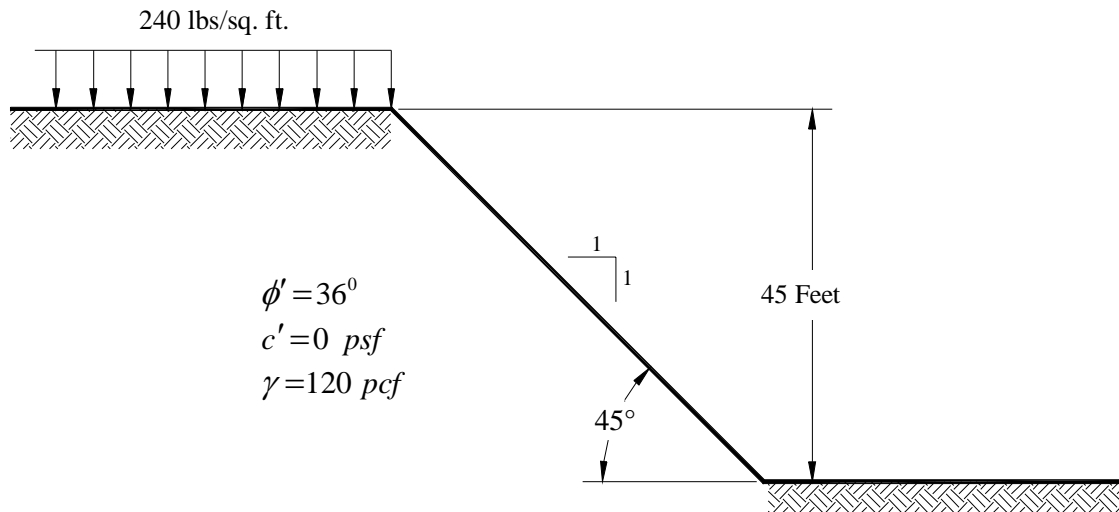

Step 1: Determine the equivalent height of the slope.

$$H' = H + \frac{q}{\gamma}$$

$$H' = 45 \text{ ft} + \frac{240 \text{ psf}}{120 \text{ pcf}}$$

$$H' = 47 \text{ feet}$$

Step2: Calculate the factored soil friction angle.

$$\phi'_f = \tan^{-1}\left(\frac{\tan \phi'}{FS}\right)$$

$$\phi'_f = \tan^{-1}\left(\frac{\tan 36^\circ}{1.5}\right)$$

$$\phi'_f = 25.8^\circ$$

Step 3: Obtain K from the chart.

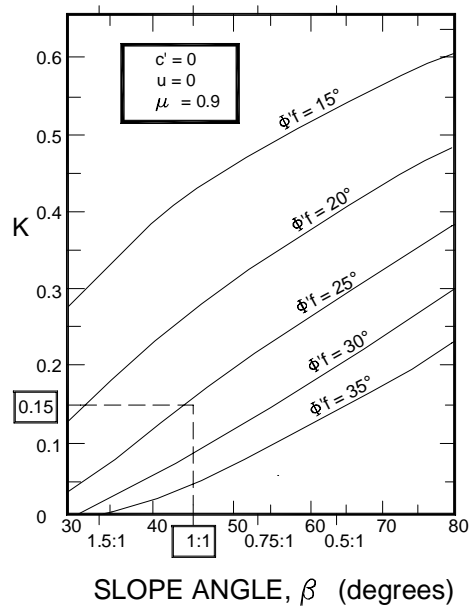

$$K = 0.15$$

Step 4: Calculate the total geogrid force.

$$T_{\max} = 0.5 \times K \times \gamma \times (H')^2$$

$$T_{\max} = 0.5 \times 0.15 \times 120 \text{ pcf} \times (47 \text{ ft})^2$$

$$T_{\max} = 19,881 \frac{\text{lb}}{\text{ft}}$$

Step 5: Select the geogrid design strength and calculate the number of geogrid layers.

Because of the considerable height of the slope, we will use three different geogrid types to maximize the efficiency of the design. We will divide the slope into three zones and apply the following tensile force distribution to each zone:

$$T_{Bottom} = \frac{1}{2} T_{max}$$

$$T_{Middle} = \frac{1}{3} T_{max}$$

$$T_{Top} = \frac{1}{6} T_{max}$$

Therefore,

$$T_{Zone1} = \frac{1}{2} \times 19,881 \frac{lb}{ft} = 9940.5 \frac{lb}{ft}$$

$$T_{Zone2} = \frac{1}{3} \times 19,881 \frac{lb}{ft} = 6,627 \frac{lb}{ft}$$

and

$$T_{Zone3} = \frac{1}{6} \times 19,881 \frac{lb}{ft} = 3,313.5 \frac{lb}{ft}$$

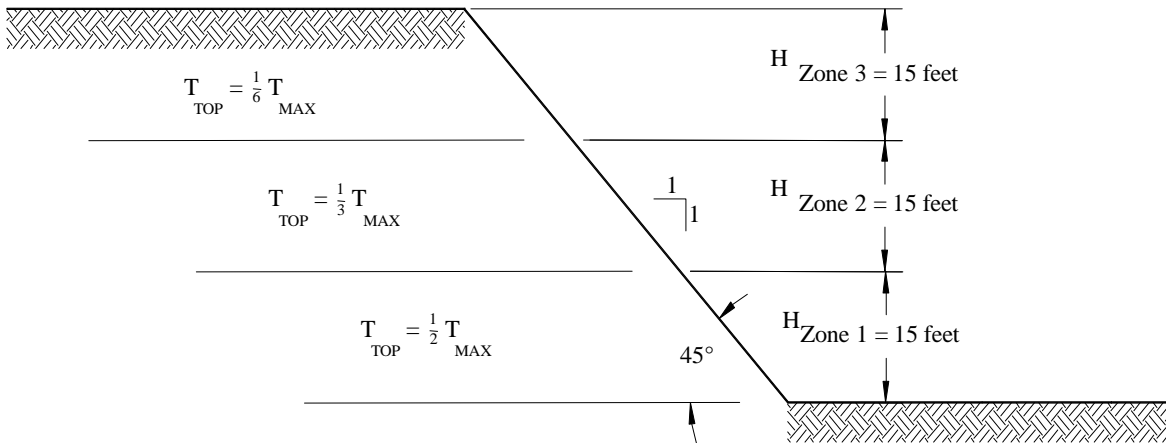

For **Zone 1**, use **Grid A** with the following long-term design strength (LTDS):

$$LTDS = \frac{T_{ult}}{RF_{CR} \times RF_{ID} \times RF_D}$$

$$LTDS = \frac{3,872 \frac{lb}{ft}}{1.6 \times 1.10 \times 1.10} = 2,000 \frac{lb}{ft}$$

The required number of layers of **Grid A** is determined by:

$$N = \frac{T_{max}}{LTDS} = \frac{9,940.5 \frac{lb}{ft}}{2,000 \frac{lb}{ft}} = 4.97, \text{ use } \underline{5 \text{ layers}}$$

The **Grid A** spacing in **Zone 1** is determined using the following:

$$S_v = \frac{H}{N} = \frac{H_{Zone1}}{N} = \frac{15 ft}{5 layers} = 3 feet, \text{ Use } 3.0 ft$$

For **Zone 2**, use **Grid B** with following long-term design strength (LTDS):

$$LTDS = \frac{T_{ult}}{RF_{CR} \times RF_{ID} \times RF_D}$$

$$LTDS = \frac{2,904 \frac{lb}{ft}}{1.6 \times 1.10 \times 1.10} = 1,500 \frac{lb}{ft}$$

The required number of layers of **Grid B** is determined by:

$$N = \frac{T_{max}}{LTDS} = \frac{6,627 \frac{lb}{ft}}{1,500 \frac{lb}{ft}} = 4.418, \text{ use } \underline{5 \text{ layers}}$$

The **Grid B** spacing in **Zone 2** is determined using the following:

$$S_v = \frac{H}{N} = \frac{H_{Zone2}}{N} = \frac{15\text{ft}}{5\text{layers}} = 3\text{ feet}, \text{ Use } 3\text{ ft}$$

For **Zone 3**, use **Grid C** with following long-term design strength (LTDS):

$$LTDS = \frac{T_{ult}}{RF_{CR} \times RF_{ID} \times RF_D}$$
$$LTDS = \frac{1,452 \frac{lb}{ft}}{1.6 \times 1.10 \times 1.10} = 750 \frac{lb}{ft}$$

The required number of layers of **Grid C** is determined by:

$$N = \frac{T_{max}}{LTDS} = \frac{3,313.5 \frac{lb}{ft}}{750 \frac{lb}{ft}} = 4.42, \text{ use } \underline{5\text{ layers}}$$

The **Grid C** spacing in **Zone 3** is determined using the following:

$$S_v = \frac{H}{N} = \frac{H_{Zone1}}{N} = \frac{15\text{ft}}{5\text{layers}} = 3\text{ feet}, \text{ Use } 3\text{ ft}$$

Step 6: Obtain length ratios and calculate geogrid lengths.

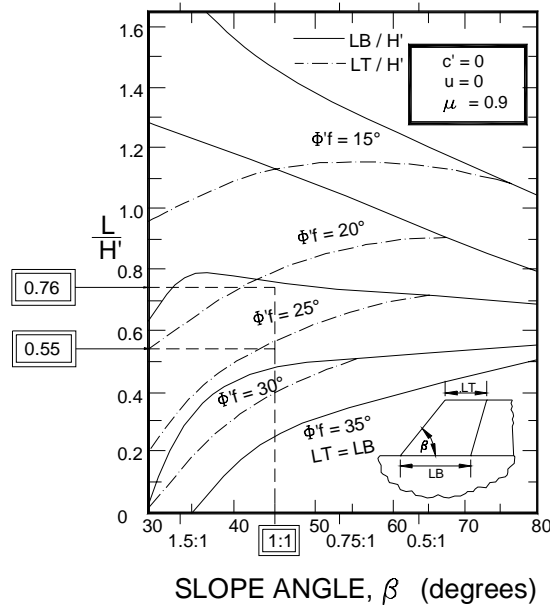

From the chart, $\frac{L_T}{H'} = 0.55$ and $\frac{L_B}{H'} = 0.76$, therefore,

$$L_T = 0.55 \times H' = 0.55 \times 47 \text{ feet} = 26 \text{ feet}, \text{ and}$$

$$L_B = 0.76 \times H' = 0.76 \times 47 \text{ feet} = 36 \text{ feet}$$

Step 7: Draw the final section. We now have the required elements to complete the preliminary design. The following figure illustrates the above design. Note that the lengths of the geogrid layers in the individual zones are equal. This is done to facilitate the work of the installer in the field. He needs only to cut geogrids to one specific length rather than have to measure awkward lengths and remember to place them at the proper elevation.

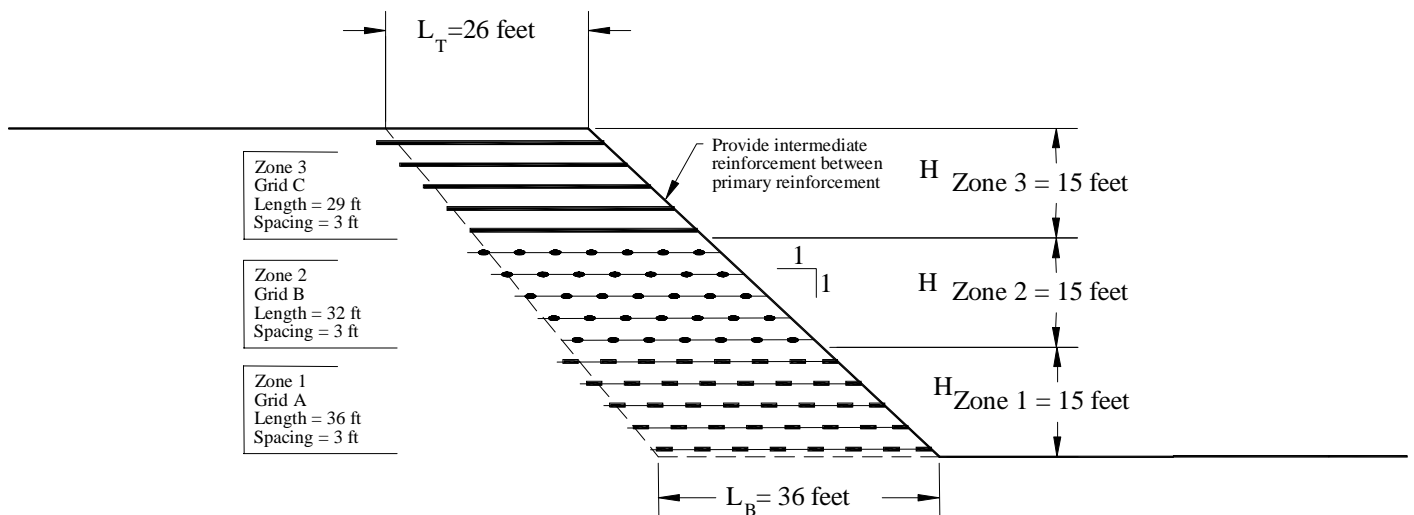

COMMENTS

Note that the primary reinforcement in each zone is spaced at 3-foot intervals in the above cross section. Experience has shown that placing and compacting soil layers exceeding 12 to 18-inches in height at a 45 degree slope angle is difficult, if not impossible. Short of adding a rigid-like facing to stabilize the soil at the surface of the structure, it is sometimes beneficial to insert intermediate reinforcing (4-ft minimum embedment length) between the widely spaced primary reinforcement. The sketch below illustrates the use of intermediate reinforcement for the purpose of enhancing the stability of surface soils placed at sharp slope angles. Surficial stability design methods can be employed to determine tensile strength and embedment length requirements for the intermediate reinforcement.

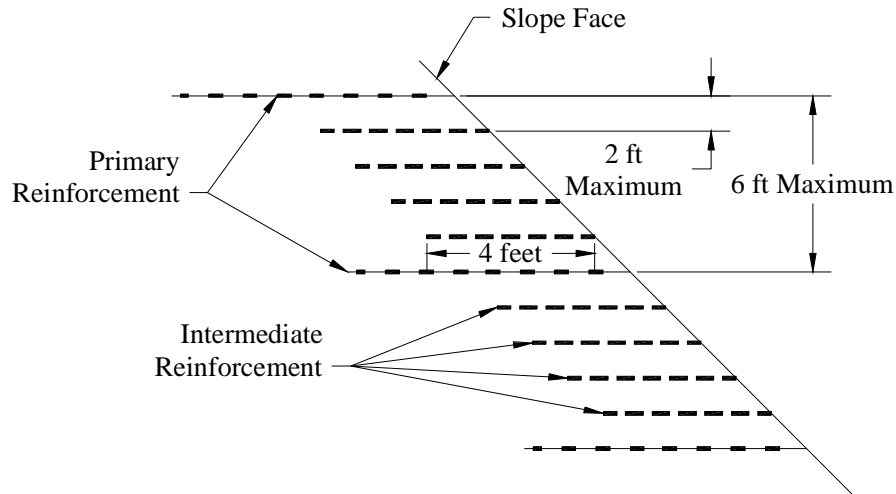

Standard Geogrid Specification

SECTION 02____

GEOGRID REINFORCEMENT

PART 1 GENERAL

1.1 SECTION INCLUDES

- A. Geosynthetic to provide reinforcement for mechanically stabilized earth retaining structures (walls, slopes and embankments).
- B. Reinforced Backfill.

1.2 RELATED SECTIONS

- A. Document 00300 - Information Available to Bidders: Geotechnical Report; Bore hole locations and findings of subsurface materials.
- B. Section 01400 - Testing and Inspection Services.
- C. Section 02200 - Site Preparation.
- D. Section 02300 - Earthwork; Excavation and subgrade preparation.
- E. Section 02310 - Grading.
- F. Section 02315 - Excavation.
- G. Section 02316 - Fill and Backfill.
- H. Section 02920 - Lawns and Grasses; Ground cover at finished grade.

1.3 REFERENCES

- A. American Association of State Highway and Transportation Officials (AASHTO)
 - 1. AASHTO T289 - Determining pH of Soil for Use in Corrosion Testing.
- B. ASTM, International
 - 1. ASTM D 422 – Gradation of Soils.
 - 2. ASTM D 424 – Atterberg Limits of Soils.
 - 3. ASTM D 698 - Standard Test Method for Laboratory Compaction Characteristics of Soil Using Standard Effort.
 - 4. ASTM D1556 - Standard Test Method for Density of Soil in Place by the Sand-Cone Method.
 - 5. ASTM D 2167 - Standard Test Method for Density and Unit Weight of Soil in Place by the Rubber Balloon Method.
 - 6. ASTM D 2922 - Standard Test Method for Density of Soil and Soil-Aggregate in Place by Nuclear Methods (Shallow Depth).
 - 7. ASTM D 3017 - Standard Test Method for Water Content of Soil and Rock in Place by Nuclear Methods (Shallow Depth).
 - 8. ASTM D 4354 - Standard Practice of Sampling Geosynthetics for Testing.
 - 9. ASTM D 4595 - Standard Test Method of Tensile Properties of Geotextiles by the Wide Width Strip Method.
 - 10. ASTM D 4759 - Standard Practice for Determining the Specification Conformance of Geosynthetics.

11. ASTM D 5262 - Standard Test Method for Evaluating the Unconfined Tension Creep Behavior of Geosynthetics.
12. ASTM D 5818 - Standard Practice for Obtaining Samples of Geosynthetics from a Test Section for Assessment of Installation Damage.
13. ASTM D 6637 – Determining Tensile Properties of Geogrids by the Single or Multi-Rib Test Method.
14. ASTM D 6706 – Standard Test Method for Measuring Geosynthetic Pullout Resistance in Soil.
15. ASTM D 6992 - Standard Test Method for Accelerated Tensile Creep and Creep-Rupture of Geosynthetic Materials Based on Time-Temperature Superposition Using the Stepped Isothermal Method.

C. Geosynthetic Research Institute (GRI)

1. GRI-GG7 - Carboxyl End Group Content of PET Yarns.
2. GRI-GG8 - Determination of the Number Average Molecular Weight of PET Yarns Based on a Relative Viscosity Value.

D. National Concrete Masonry Association (NCMA)

1. NCMA TR127A – Design Manual for Segmental Retaining Walls.
2. NCMA TR160 – Segmental Retaining Walls – Seismic Design Manual.
3. NCMA TR204 – Drainage Manual for Segmental Retaining Walls.

E. National Highway Institute (NHI) / Federal Highway Administration

1. NHI-00-043 – Mechanically Stabilized Earth Walls and Reinforced Soil Slopes Design and Construction Guidelines.

1.4 Design Requirements

- A. Design Requirements: Design reinforced soil structure in conformance with the design guidelines of NHI-00-043 or National Concrete Masonry Association. Design shall be prepared by a professional engineer registered in the state in which the project is located.

1.5 SUBMITTALS

- A. Submit under provisions of Section 01300.
- B. Manufacturer's certification that the reinforced soil system components meet the requirements of this specification and the structure design.
- C. Mill certification from the polyester fiber manufacturer certifying the molecular weight and carboxyl end group count as specified herein.
- D. A set of detailed design plans sealed by a registered professional engineer licensed in the state of the project. The plans shall include plan and elevation views of each structure, cross sections and all details, dimensions and quantities necessary to construct the structure.
- E. Samples: Two samples of each component including:
1. Geogrid: Nominal 6 inch by 10 inch (150 mm by 250 mm) of each type required.

1.6 QUALITY ASSURANCE

- A. Manufacturer Qualifications: System components manufactured by licensees or by companies approved and authorized by the component supplier.
- B. Installer Qualifications: Firm with documented experience of at least five projects of similar construction and scope. Include brief description of each project and name and phone number of owner's representative knowledgeable in each listed project.

- C. Reinforced Soil System Engineer: Firm with documented experience of at least five projects of similar construction and scope. Include brief description of each project and name and phone number of owner's representative knowledgeable in each listed project.
- D. Owner shall provide soil testing and quality assurance inspection during earthwork and slope construction operations. Installer shall provide any quality control testing or inspection not provided by the Owner. Owner's quality assurance program does not relieve the installer of responsibility for quality control and structure performance.
- E. Pre-Construction Meeting: Prior to construction of reinforced soil structures, conduct a meeting at the site with the material suppliers, reinforced soil structure installer, and the Contractor to review the reinforced soil structure requirements. Notify the Owner and the Architect at least 3 days in advance of the time of the meeting.

1.7 DELIVERY, STORAGE, AND HANDLING

- A. Store products in manufacturer's unopened packaging until ready for installation.
- B. Prevent excessive mud, fluid concrete, epoxy, or other deleterious materials from coming in contact with system components.
- C. Polymeric Materials: During storage, geosynthetic rolls shall be elevated off the ground and adequately covered to protect them from the following: site construction damage, precipitation, extended ultraviolet radiation including sunlight, chemicals that are strong acids or strong bases, flames including welding sparks, excess temperatures, and any other environmental conditions that may damage the physical property values of the geosynthetic.
- D. Store and dispose of solvent-based materials, and materials used with solvent-based materials, in accordance with requirements of local authorities having jurisdiction.

1.8 PROJECT CONDITIONS

- A. Do not place or compact fill material during wet or freezing weather that prevents achievement of specified compaction requirements.

PART 2 PRODUCTS

2.1 MANUFACTURERS

- A. Geogrid: StrataGrid and MicroGrid: Strata Systems, Inc., 380 Dahlonega Road, Suite 200, Cumming, Georgia, 30040. Tel: (770) 888-6688, Toll Free: (800) 680-7750. Fax: (770) 888-6680. Web Site: www.geogrid.com. E-mail: strata@geogrid.com.
- B. Substitutions: Not permitted.

2.2 MATERIALS

- A. System Description: Reinforced soil structure consists of a mechanically stabilized engineered backfill reinforced with StrataGrid or MicroGrid polyester soil reinforcement products.

B. Geogrid: StrataGrid shall provide the following minimum properties:

1. StrataGrid Tensile Requirements

Property	Method	SG150 lb/ft (kN/m)	SG200 lb/ft (kN/m)	SG350 lb/ft (kN/m)	SG500 lb/ft (kN/m)	SG550 lb/ft (kN/m)	SG600 lb/ft (kN/m)	SG700 lb/ft (kN/m)
T _{ult} , Ultimate Tensile Strength	ASTM D6637 (Method A)	1875 (27.4)	3600 (52.5)	5000 (73.0)	6400 (93.4)	8150 (118.9)	9100 (132.8)	11800 (172.2)
T _a , Allowable Design Strength								
With Sand, Silty, Clay Soils [D ₅₀ < 1mm]		1000 (14.6)	2011 (29.3)	2793 (40.8)	3575 (52.2)	4552 (66.4)	5083 (74.2)	6591 (96.2)
With 1" minus Angular Aggregate [D ₅₀ < 6mm]		1000 (14.6)	1919 (28.0)	2666 (38.9)	3412 (49.8)	4346 (63.4)	4852 (70.8)	6292 (91.8)
With 1.5" minus Angular Aggregate [D ₅₀ < 20mm]		916 (13.4)	1760 (25.7)	2444 (35.7)	3264 (47.6)	4157 (60.7)	4641 (67.7)	6018 (87.8)

- a. Allowable Tensile Strength (T_a) shall be defined as T_{ult} / RF. Where RF = RF_{CR} x RF_D x RF_{ID}. Reduction Factor for Creep (RF_{CR}), Reduction Factor for Durability (RF_D), and Reduction Factor for Installation Damage (RF_{ID}).
 - b. Ultimate Tensile Strength (T_{ult}) shall be the minimum average roll value (MARV) as tested per ASTM D 6637 (Method A).
 - c. Reduction Factor for Creep (RF_{CR}) shall be based on 75-year design life determined in accordance with ASTM D 5262 or ASTM D 6992. Reduction Factor for Creep (RF_{CR}) shall not be less than 1.5.
 - d. Reduction Factor for Installation Damage (RF_{ID}) shall be based on reinforced backfill type designated above or reinforced backfill gradation as indicated in the approved shop drawings or specifications. Installation damage testing and material sampling shall be in conformance with ASTM D 6637 and ASTM D 5818. Reduction Factor for Installation Damage (RF_{ID}) shall not be less than 1.05.
 - e. Reduction Factor for Durability (RF_D) shall be based on polyester fiber testing. Polyester fiber shall have a molecular weight ≥ 25,000 g/m per GRI-GG8 and a carboxyl end group (CEG) number ≤ 30 per GRI- GG7. Reduction Factor for Durability (RF_D) shall not be less than 1.10.
2. Soil Interaction Coefficient (C_i) value shall be determined from short-term effective stress pullout tests per ASTM D 6706 over the range of normal stresses encountered. The minimum C_i value shall not be less than 0.7, determined as follows:

$$C_i = \frac{F}{2Ls_N \tan(\mathbf{f})}$$

- a. F = Pullout force per ASTM D 6706, lb/ft (kN/m).
- b. L = Geosynthetic embedment length during test, ft (m).
- c. s_N = Effective normal stress, psf (kPa).
- d. f = Effective soil friction angle, degrees.

- C. Intermediate or Face Wrap Geogrid: MicroGrid or StrataGrid, as indicated in the approved shop drawings, shall provide the following minimum tensile properties:
1. Intermediate or Face Wrap Geogrid Tensile Requirements

Property	Method	SG150 lb/ft (kN/m)	MicroGrid lb/ft (kN/m)
T _{ult} , Ultimate Tensile Strength	ASTM D6637 or D4595	1875 (27.4)	2000 (29.2)
T _a , Allowable Design Strength			
With Sand, Silty, Clay Soils [D ₅₀ < 0.3mm]		1000 (14.6)	871 (12.7)
With 1" minus Angular Aggregate [D ₅₀ < 2mm]		1000 (14.6)	550 (8.0)
With 1.5" minus Angular Aggregate [D ₅₀ < 6mm]		916 (13.4)	550 (8.0)

- a. Allowable Tensile Strength (T_a) shall be defined as T_{ult} / RF. Where RF = RF_{CR} x RF_D x RF_{ID}. Reduction Factor for Creep (RF_{CR}), Reduction Factor for Durability (RF_D), and Reduction Factor for Installation Damage (RF_{ID}).
 - b. Ultimate Tensile Strength (T_{ult}) shall be the minimum average roll value (MARV) as tested per ASTM D 6637 (Method A) or ASTM D 4595.
 - c. Reduction Factor for Creep (RF_{CR}) shall be based on 75-year design life determined in accordance with ASTM D 5262 or ASTM D 6992. Reduction Factor for Creep (RF_{CR}) shall not be less than 1.5.
 - d. Reduction Factor for Installation Damage (RF_{ID}) shall be based on reinforced backfill type designated above or reinforced backfill as indicated in the approved shop drawings or specifications reinforced backfill gradation. Installation damage testing and material sampling shall be in conformance with ASTM D 6637, ASTM D 4595 and ASTM D 5818. Reduction Factor for Installation Damage (RF_{ID}) shall not be less than 1.05.
 - e. Reduction Factor for Durability (RF_D) shall be based on polyester fiber testing. Polyester fiber shall have a molecular weight ≥ 25,000 g/m per GRI-GG8 and a carboxyl end group (CEG) number ≤ 30 per GRI- GG7. Reduction Factor for Durability (RF_D) shall not be less than 1.10.
- D. Reinforced Backfill: Granular fill with a pH range of 3 to 10, when tested in accordance with AASHTO T 289 and graded as follows:
1. 100 percent passing a 2-inch (50 mm) sieve.
 2. 100 to 75 percent passing a 3/4-inch (19 mm) sieve.
 3. 100 to 20 percent passing a No. 4 sieve (4.75 mm).
 4. 0 to 60 percent passing a No. 40 sieve (0.425 mm).
 5. 0 to 35 percent passing a No. 200 sieve (0.075 mm).
 6. PI ≤ 15
 7. LL ≤ 30

PART 3 EXECUTION

3.1 PREPARATION

- A. Do not begin installation until excavation, foundation preparation and leveling pad have been completed, properly prepared, and inspected per project specifications.

- B. If subgrade preparation is the responsibility of another installer, notify Architect / Owner's Geotechnical Engineer of unsatisfactory preparation. Do not begin work until unsatisfactory conditions have been rectified as directed by the Owner's Geotechnical Engineer.
- C. Excavation:
 - 1. Excavate the subgrade vertically to the plan elevation and horizontally to the extent of the geogrid lengths.
 - 2. Remove soils not meeting required strength and replace with approved materials by the Owner's Geotechnical Engineer.
 - 3. Protect excavated materials to be used for backfilling the reinforcement zone from the weather.
- D. Foundation Preparation:
 - 1. Over-excavated areas of the subgrade shall be filled in maximum loose lifts of 10 inches (250 mm) and shall be compacted to a minimum of 95 percent Standard Proctor Dry Density with -1% to +2% of optimum moisture content in accordance with ASTM D 698.
 - 2. Owner's Geotechnical Engineer will inspect the subgrade soil for the reinforced zone to ensure proper bearing strength in accordance with the specified Field Quality Control provisions.

3.2 CONSTRUCTION

- A. Construct reinforced soil structure in accordance with the approved shop drawings and Construction and Quality Control Manual supplied by the manufacturer.
- B. Geogrid placement:
 - 1. Unroll the geogrid and cut to the length indicated in the approved shop drawings.
 - 2. Place geogrid on level and compacted reinforced fill at locations indicated in the approved shop drawings.
 - 3. Primary strength direction of the geogrid shall be placed perpendicular to the face of the structure or aligned as indicated in the approved shop drawings.
 - 4. Pull the geogrid taut to remove slack in the geogrid.
 - 5. Stake or pin the geogrid near the end to maintain alignment and to prevent development of slack during backfill placement.
 - 6. Adjacent embedment lengths of geogrid shall abut to provide 100% coverage at elevations requiring geogrid reinforcement, as indicated in the approved shop drawings.
 - 7. Place a minimum of 3 inches (75 mm) of fill between overlapping layers of geogrid where overlapping occurs behind curves and corners.
 - 8. Construction vehicles shall not be operated directly on the geogrid. A minimum of 6 inches (150 mm) of fill cover over the geogrid is required for operation of construction vehicles in the reinforced zone.
 - 9. Turning of vehicles should be avoided to prevent dislocation or damage to the geogrid.
 - 10. Primary geogrid may not be overlapped or connected mechanically to form splices in the primary strength direction.
- C. Reinforced backfill:
 - 1. Place the reinforced backfill material in maximum compacted lifts of 8 inches (200 mm) and compact to a minimum Standard Proctor Dry Density of 95 percent within -1 to +2 percent of optimum moisture content, per ASTM D 698. Compaction shall be achieved throughout the full lift thickness. Minimum compaction shall meet or exceed the requirements stated or as required by the project specifications, whichever is more stringent.
 - 2. Use only walk-behind compaction equipment within 3 feet (1 meter) of the structure facing. Use a minimum of 3 passes to compact this zone.
 - 3. Required level of compaction shall be achieved throughout the entire reinforced backfill zone, as measured from the back of the facing unit to the end of geogrid reinforcement. Reinforced fill zone limits shall be as indicated on the approved shop drawings.

4. Smooth and level the backfill as indicated so that the geogrid lays flat. Grade shall not slope towards the front face of the structure.
5. Separate reinforced fill from the adjacent soil with geotextile, as indicated in the approved shop drawings

3.3 FIELD QUALITY CONTROL

- A. Quality Assurance: Testing and Inspection will be provided by the Owners Testing Agency as specified in Section 01400 Testing and Inspection Services. Notify the Architect / Owner's Geotechnical Engineer 72 hours in advance of testing.
- B. Quality Control: Testing and Inspection shall be provided by an independent laboratory provided by the Contractor and acceptable to the Architect / Owner's Geotechnical Engineer.
- C. Perform laboratory material tests in accordance with ASTM D 698, D 422, and D 424.
- D. Perform in place compaction tests in accordance with the following:
 1. Density Tests: ASTM D 1556, ASTM D 2167, or ASTM D 2922 as appropriate for material tested.
 2. Moisture Tests: ASTM D 3017.
- E. Minimum Frequency of Tests, or as stated in the contract documents:
 1. Leveling Pad Trench: A minimum rate of one test per 100 feet (30 m) of trench.
 2. Subgrade Soil: A minimum rate of one test per 50 feet (15 m) length of structure.
 3. Reinforced Backfill:
 - a. Conduct gradation and plasticity index test at a minimum rate of one test per 2000 cubic yards (1500 cubic meters) and whenever the appearance and behavior of the backfill changes noticeably.
 - b. Compaction control testing of the reinforced backfill should be performed on a regular basis during the entire construction project. Conduct compaction control test (Density and Moisture) at a minimum rate of one test within the reinforced backfill zone per every 5 ft (1.5 m) of vertical height for every 100 ft (30 m) of length, approximately every 500 square feet (45 square meters) of vertical face area.

END OF SECTION

Slope Reinforcement
Preliminary Design & Cost Estimate Worksheet

Slope Reinforcement Preliminary Design & Cost Estimate Worksheet

The following worksheet provides the design engineer and estimator a quick way to estimate the total geogrid quantity and cost for reinforced steep slope projects.

Step 1: Design Assumptions

- Extensible reinforcement elements are used,
- Slopes are constructed with uniform, cohesionless soil; ϕ' , $c' = 0$, analysis appropriate,
- No pore pressures within the slope,
- No seismic loading,
- Competent, level foundations,
- Flat slope face and horizontal slope crest,
- Uniform surcharge load at top of slope, and
- Horizontal reinforcement layers with coefficient of interaction (C_i) equal to 0.9.

Step 2: Design Parameters

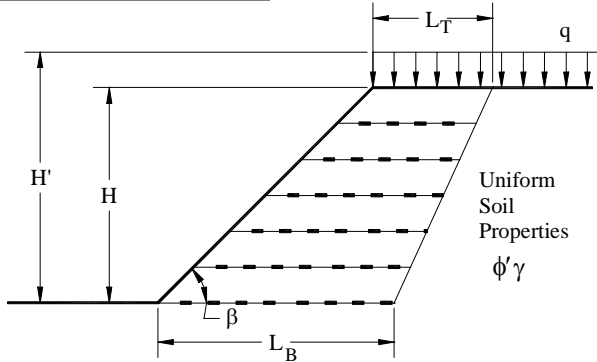

$H =$ Slope Height (ft) = _____

$\beta =$ Slope Angle (deg) = _____

$FS =$ Factor of Safety = _____

$\phi' =$ Soil Friction Angle (deg) = _____

$\gamma =$ Soil Moist Unit Weight (pcf) = _____

$\phi'_f =$ Soil Friction Angle (deg) = _____

$$\phi'_f = \tan^{-1} \left(\frac{\tan \phi'}{FS} \right)$$

$q =$ Uniform Surcharge (psf) = _____

$H' =$ Equivalent Slope Height = _____

$$H' = H + \frac{q}{\gamma}$$

$SL =$ Running Slope Length (ft) = _____

Step 3: Horizontal Reinforcement Force (T) Requirement

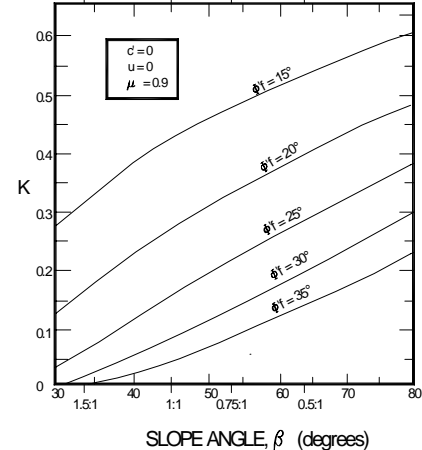

$K =$ Force Coefficient (from Figure above) = _____

$T_{max} =$ maximum tensile force requirement (lb/ft) = _____

$$T_{max} = 0.5 \times K \times \gamma \times (H')^2$$

Step 4: Determine Number of Geogrid Layers and Select Primary Geogrid

$N_{min} =$ Minimum Number of Layers = _____

$$N_{min} = \frac{T_{max}}{LTDS}, \text{ where}$$

$LTDS =$ Long Term Design Strength of the Geogrid

$$LTDS = \frac{T_{ult}}{RF_{CR} \times RF_{ID} \times RF_D} \text{ where:}$$

$T_{ult} =$ ultimate tensile strength of the reinforcement as per ASTM D6637,

$RF_{CR} =$ reduction factor due to creep,

$RF_{ID} =$ reduction factor due to installation damage, and

$RF_D =$ reduction factor due to durability.

*Refer to current StrataGrid Product Data Sheet for design $LTDS$ values. Data Sheet available at www.geogrid.com or 800-680-7750.

Step 5: Optimize Primary Geogrid Selection and Spacing

The next step in the procedure is to select the appropriate primary geogrid and calculate the number of layers required. At this point in the analysis, the designer must choose a geogrid so that the resulting spacing calculations yield acceptable values. For example, the spacing of primary geogrid layers at the bottom of a slope should not be less than 8 inches to 12 inches. This corresponds to typical earthwork fill thickness. Conversely, the primary geogrid spacing should be no greater than 4 feet. If calculations yield geogrid spacing less than the practical limit, then a stronger primary geogrid should be chosen. Alternatively, if the calculations yield geogrid spacing greater than 4 feet, a lighter geogrid can be selected.

Calculate appropriate maximum primary geogrid spacing at the bottom of the slope:

$S_v = \text{Geogrid Spacing (ft)} = \underline{\hspace{2cm}}$

$$S_v = \frac{0.5 \times H'}{N_{\min}}$$

- If S_v is greater than 4 feet, use of a lighter geogrid is appropriate. Return to Step 4.
- If S_v is less than 8 to 12 inches, use of a stronger geogrid is required. Return to Step 4.

Note that T_{max} for a low section of slope is equal to the total geogrid force requirement for the entire height of the slope. For higher slope sections, T_{max} can be distributed over several zones. This results in an efficient and cost-effective design. (see Manual for details)

Step 6: Determine the Required Primary Geogrid Length

From the chart on the following figure, determine the required reinforcement length at the top (L_T) and at the bottom (L_B) of the reinforced section.

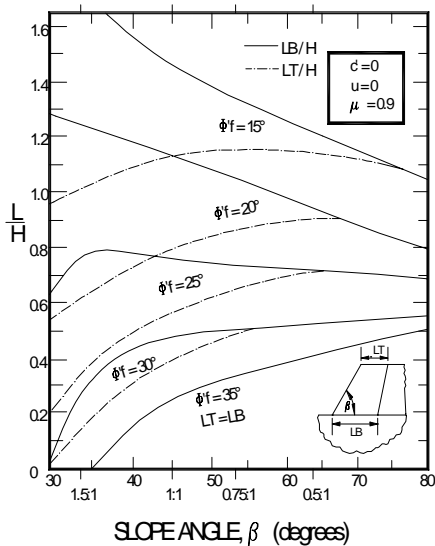

Choose the appropriate L/H' ratio for a given slope angle (β) and a factored soil friction angle (ϕ'_f).

$L_T =$ Minimum Required Length of geogrid at the top of the Reinforced Steep Slope

$L_B =$ Minimum Required Length of geogrid at the bottom of the Reinforced Steep Slope

$$L_T \geq \left(\frac{L_T}{H'} \times H' \right) \geq \underline{\hspace{2cm}} \text{ ft}$$

$$L_B \geq \left(\frac{L_B}{H'} \times H' \right) \geq \underline{\hspace{2cm}} \text{ ft}$$

Step 7: Estimate Total Geogrid Quantity

$N = N_{\min}$ (rounded up to a whole number)

$Q_{approx} =$ approximate quantity of primary geogrid per running ft of slope

$$Q_{approx} = 1.2 \times N(0.33L_T + 0.67L_B) = \underline{\hspace{2cm}} \text{ ft}^2/\text{ft}$$

$Q_{wrap} =$ approximate quantity of intermediate grid for wrapping at the face of the slope.

$$Q_{wrap} = N \times 8 \text{ ft} = \underline{\hspace{2cm}} \text{ ft}^2/\text{ft}$$

$Q_{int} =$ approximate quantity of intermediate grid (no wrapping at the face of the slope).

$$Q_{int} = (H - N) \times 5 \text{ ft} = \underline{\hspace{2cm}} \text{ ft}^2/\text{ft}$$

Calculate Total Approximate Geogrid Quantity

$Q_{total} =$ quantity of geogrid per running ft x slope length

Primary Geogrid: Stratagrid $\underline{\hspace{2cm}}$

$$Q_{total} = Q_{approx} \times SL = \underline{\hspace{2cm}} \text{ ft}^2$$

Intermediate Geogrid: Stratagrid $\underline{\hspace{2cm}}$

$$Q_{total} = Q_{int} \times SL = \underline{\hspace{2cm}} \text{ ft}^2$$

Step 8: Estimate Total Cost of Geogrid/Running Foot

Primary Geogrid: Unit Cost of Stratagrid $\underline{\hspace{2cm}} \text{ \$/ft}^2$

$$Cost_{total} = Q_{approx} \times \text{Unit Cost} = \underline{\hspace{2cm}} \text{ \$/ft}$$

Intermediate Geogrid: Unit Cost of Stratagrid $\underline{\hspace{2cm}} \text{ \$/ft}^2$

$$Cost_{total} = Q_{int} \times \text{Unit Cost} = \underline{\hspace{2cm}} \text{ \$/ft}$$